

Model KVA100

KVA oil-flooded, multi-vane vacuum pumps are single stage, air cooled and direct driven. This simple design ensures the reliability and the durability that is required in the vacuum industry.

Improved Performance

The performance of the KVA rotary vane vacuum pump has been optimized to provide even deeper vacuum levels than before. Most models can achieve ultimate pressure levels near 0.1 mbar.

Rugged and Reliable

Tuthill has built a global reputation for having some of the most rugged and reliable equipment in the industry. The KVA rotary vane vacuum pump is no exception and has many years of proven application experience.

Custom Engineered Systems

Tuthill has a knowledgeable team of vacuum application experts who will work with you to design a vane pump vacuum system that is tailored to your specific needs.

Easy to Maintain and Operate

The KVA has been engineered to provide convenient service access to both the oil and filters. Its direct-coupled and air-cooled design requires very little additional maintenance.

Compact and Quiet

The small footprint of the KVA pump allows for maximized tabletop and floor space. A smooth and quiet operation can be expected due to the intentional pump design and vibration isolation.



Features

- Non-metallic vanes
- Oil level sight glass
- Vibration isolators
- Anti-suck back valve
- Integral exhaust filters
- TEFC high efficiency motor
- Models KVA 25-630 include spin-on oil filter
- Drop-in replacements for Busch R 5 Series™* Vane Pumps

* R 5 series is a trademark of Busch, Inc.

Specifications Table

NOMINAL DISPLACEMENT	60 Hz	CFM	71
	50 Hz		60
	60 Hz	m ³ /h	120
	50 Hz		100
ULTIMATE PRESSURE	Torr		0.11
	mbar		0.14
MOTOR	3 Phase	Hp	5
ROTATIONAL SPEED	60 Hz		1740
NOISE LEVEL	dba	60Hz	68
OIL CAPACITY	Quarts		2.9
	Liters		2.7
CONNECTIONS	Inlet NPT		1 1/4"
	Outlet NPT		1 1/4"
APPROX. WEIGHT (with pump & motor, no oil)	lbs.		165
	kg		75

Dimensions

Values shown are approximate and should not be used for construction. Certified drawings are available through your local Tuthill Vacuum & Blower Systems Sales Professional. All dimensions are shown in inches and millimeters.

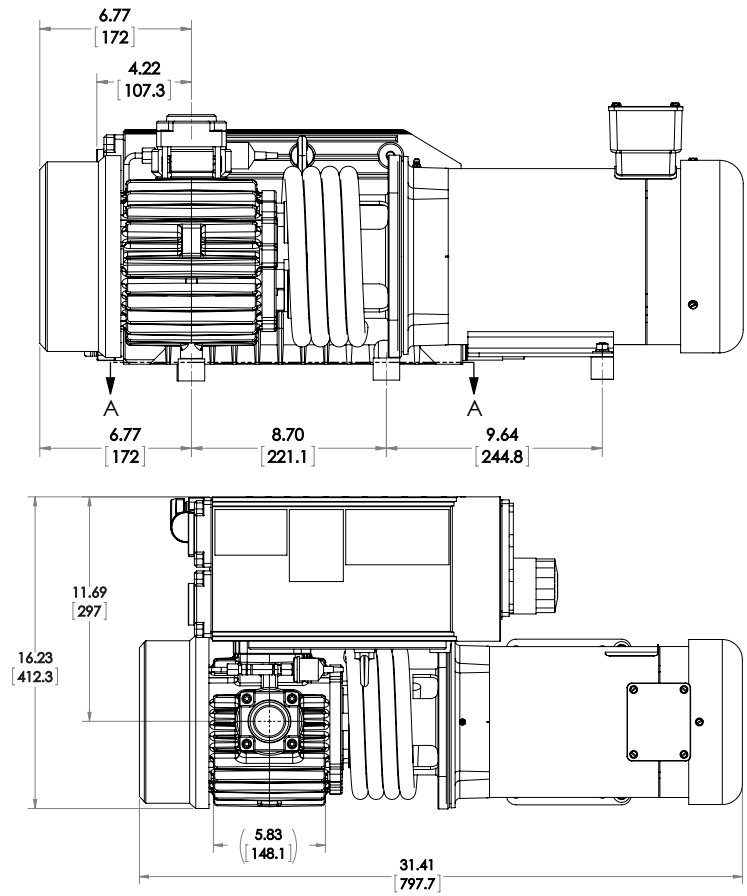
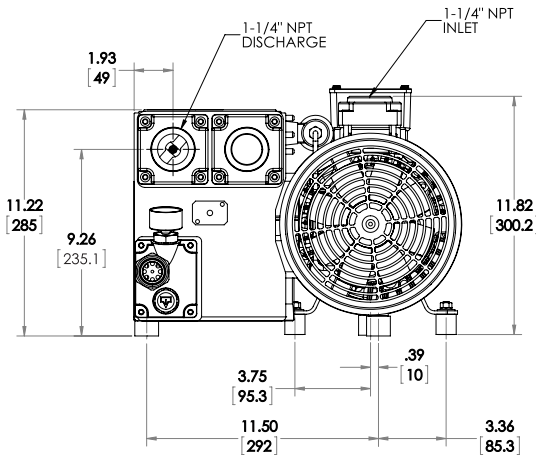

Performance Curve

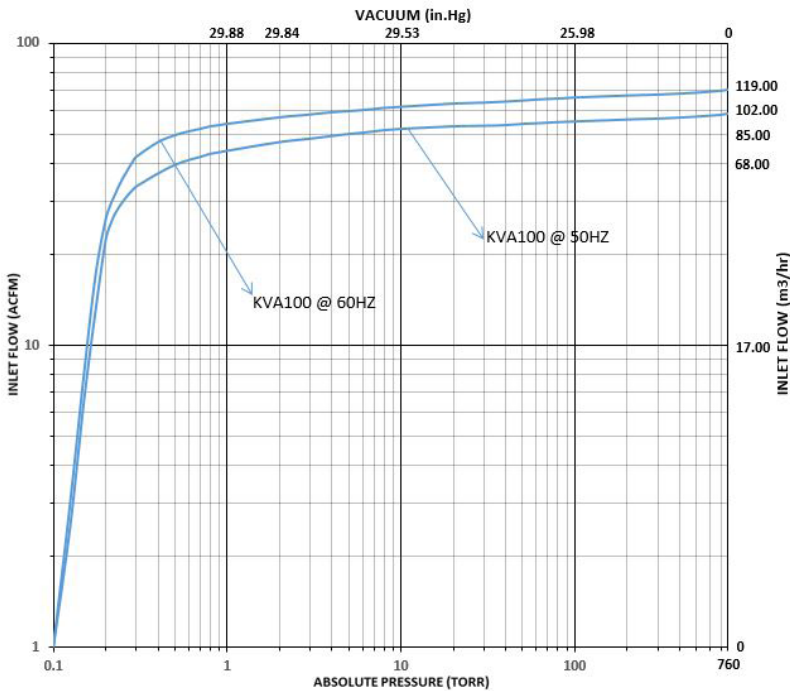

Your Local Tuthill Vacuum Blower Systems Sales Professional:



Tuthill Vacuum & Blower Systems
 4840 West Kearney Street
 Springfield, Missouri USA 65803-8702
 o 417.865.8715 800.825.6937 f 417.865.2950
tuthillvacuumblower.com

